



27180 95th Ave  
 Suite 3370  
 Wilsonville OR 97070  
 (503) 570-8689  
 (503) 570-88780 fax

# Boiler Master Control Panel

McMicken Heights Elementary  
 Seattle, Washington

- Boiler control
- Boiler pump control
- Boiler sequencing
- Alarms
- HOA Switch
- Building automation system interface
  - Network
  - Hard wired points
- PLC operator interface
  - Summary Screen  
 Loop & boiler temperatures, Building supply setpoint, Boiler details—firing rate, status, System disabled-local, off, remote, Reset alarm button
  - Boiler Screens  
 Water temperature, Status indicators—limit, available, enable, alarm, pump status, draft fan status, Firing rate, Manual rate controls
  - Lead Boiler Alternate Screen  
 Lead boiler indicator, Alternate hours, Countdown, Reset, Enabled/Disabled
  - Lead/Lag Settings Screen  
 System start/stop temperature offsets, Lag start/stop PID values, Lag delay, Lag hold temp offset
  - PID Setup Screen  
 Setpoint source, Constant setpoint, Network setpoint, Remote setpoint, PID settings, Mod Delay, PID output,
  - Outside Air Reset Screen  
 Outside air temperature, Outside air setpoint, Reset settings, Shutdown temp
  - Parameters  
 Mod stroke time/boiler start time, Heat fail alarm temp/timeout, Low/high boiler temp, Operator settings, HMI config
  - Secure Setting Screen  
 Min setp/max setp, Save settings/restore settings



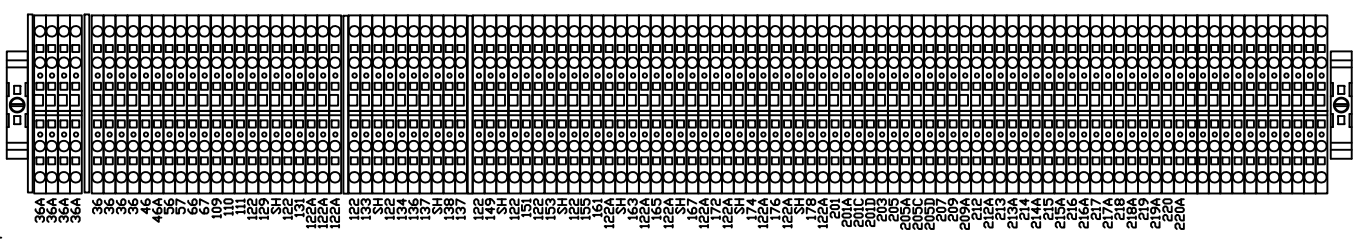
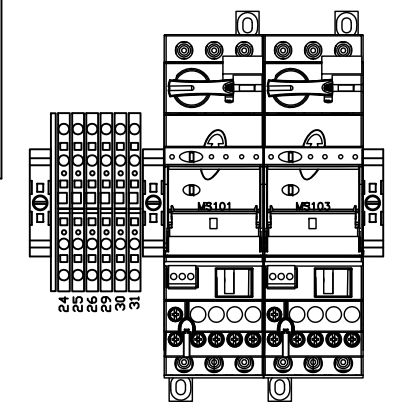
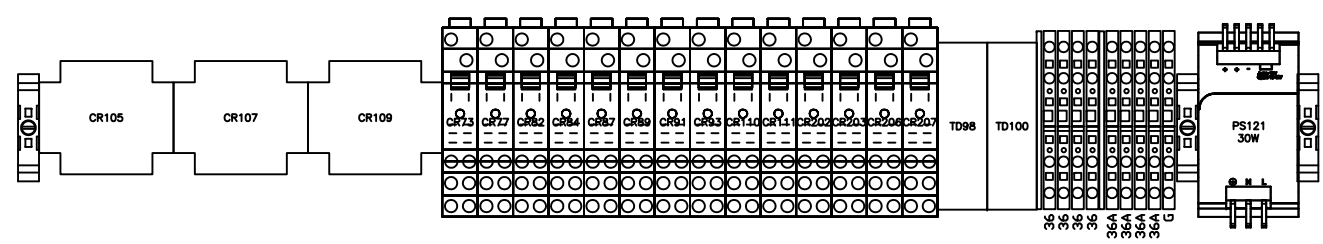
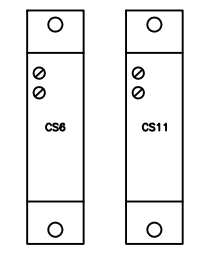
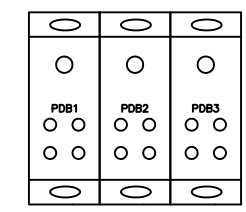
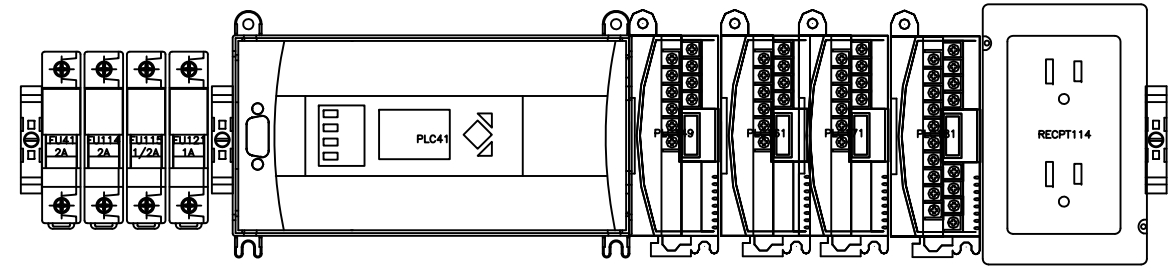
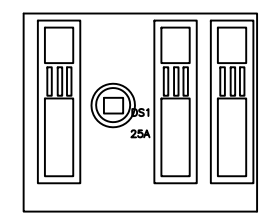
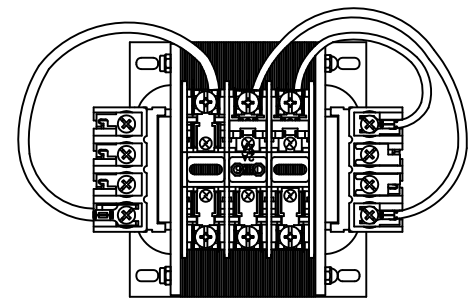
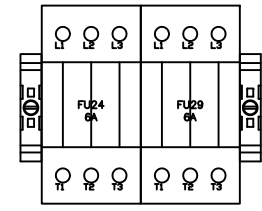
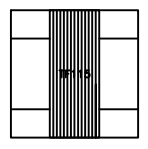
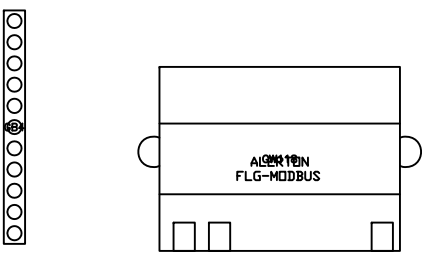
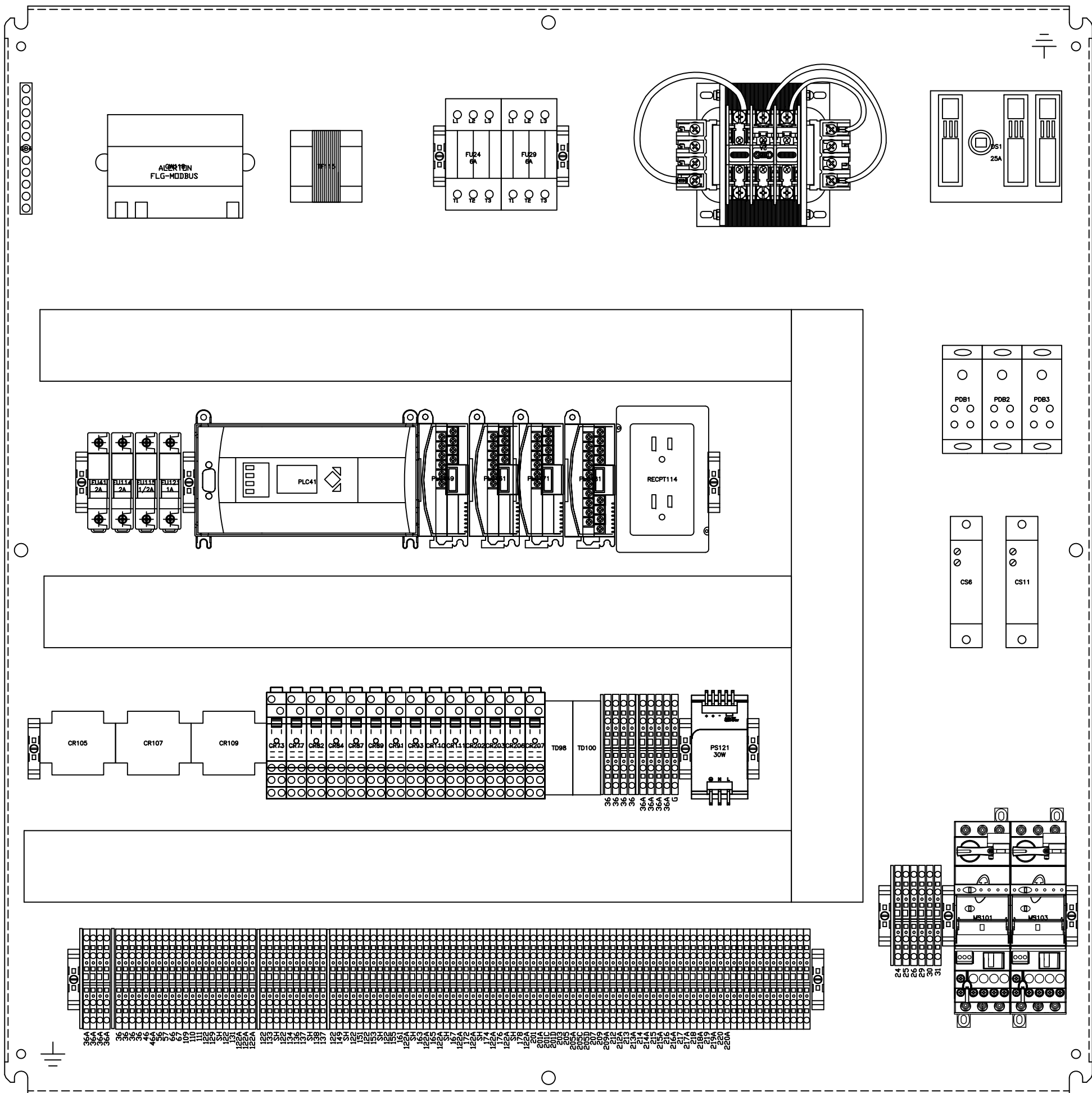

REVISION  
2

THIS DRAWING AND DESIGN IS THE PROPERTY OF PROCTOR SALES, INC. NEITHER THE DRAWING, REPRODUCTION OF IT, NOR INFORMATION DERIVED FROM IT IS TO BE GIVEN TO OTHERS WITHOUT WRITTEN PERMISSION. NO USE IS TO BE MADE WHICH IS OR MAY BE INJURIOUS TO PROCTOR SALES INCORPORATED.

NO.	DATE	BY	REVISION
2	10-20-10	Jmg	REMOVED FUSES AND TERMINALS FOR MIX VALVES
1	10-15-10	Jmg	REMOVED GND TERM TO 'G', SHLD TERMS TO 'SH'
1	10-15-10	Jmg	CHANGED TERMS 201B205B TO 201A205A
1	10-15-10	Jmg	REMOVED TERMS 112K113, ADDED 201D405D

**PROCTOR SALES, INC**  
 27180 SW 95TH AVENUE ST 3370  
 WILSONVILLE, OREGON 97070  
 503-570-8689

**PSI**

ALASKA - OREGON - WASHINGTON

JOB NO 14467-09	
DRAWN BY Jmg	CHECKED BY
ENGINEER	
SCALE	DATE 11-10-09
DWG NO 14467-BP	
SHEET NO 12 OF 13	

CAD DWG FILE 14467 MCMicken Heights Elementary - BP.dwg

# INTERCONNECT DRAWING (1 OF 3)

## BOILER CONTROL PANEL

## BOILER CONTROL PANEL

## BUILDING AUTOMATION SYSTEM (CONTINUED)

REVISION  
2

THIS DRAWING AND DESIGN IS THE PROPERTY OF PROCTOR SALES, INC. NEITHER THE DRAWING, REPRODUCTION OF IT, NOR INFORMATION DERIVED FROM IT IS TO BE GIVEN TO OTHERS WITHOUT WRITTEN PERMISSION. NO USE IS TO BE MADE WHICH IS OR MAY BE INJURIOUS TO PROCTOR SALES INCORPORATED.

NO.	DATE	BY	JOB	REVISION	LIST ANALOG RANGES, SHOW DRY CONTACTS

**PROCTOR SALES, INC**  
 27180 SW 95TH AVENUE ST 3370  
 WILSONVILLE, OREGON 97070  
 503-570-8689

PSI

ALASKA - OREGON - WASHINGTON

MCMICKEN HEIGHTS ELEMENTARY BOILER CONTROL PANEL	
JOB NO 14467-09	
DRAWN BY Job	CHECKED BY
ENGINEER	
SCALE	DATE 11-10-09
DWG NO 14467-IC	
SHEET NO 1 OF 13	

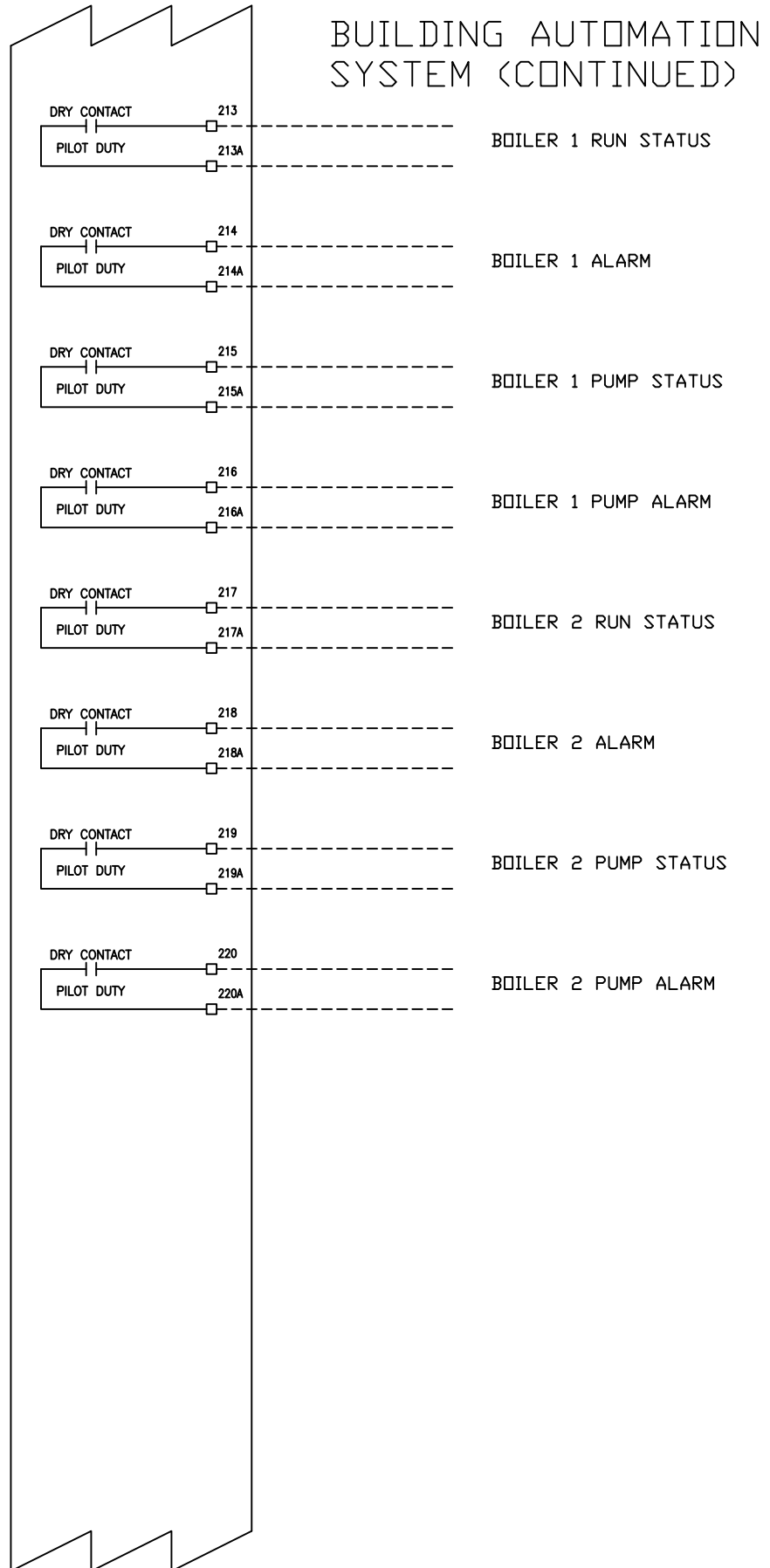
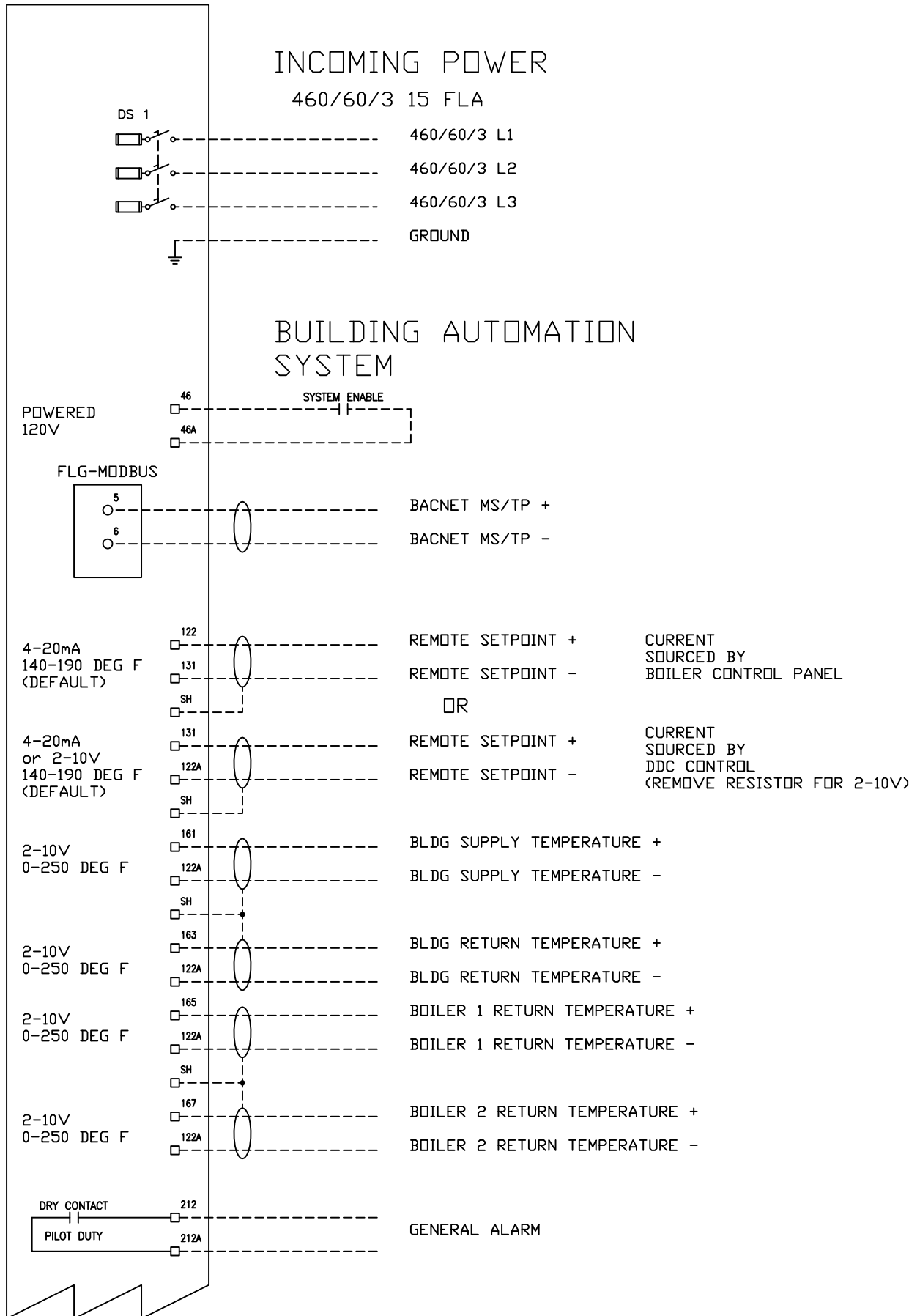

# INTERCONNECT DRAWING (2 OF 3)

## BOILER CONTROL PANEL

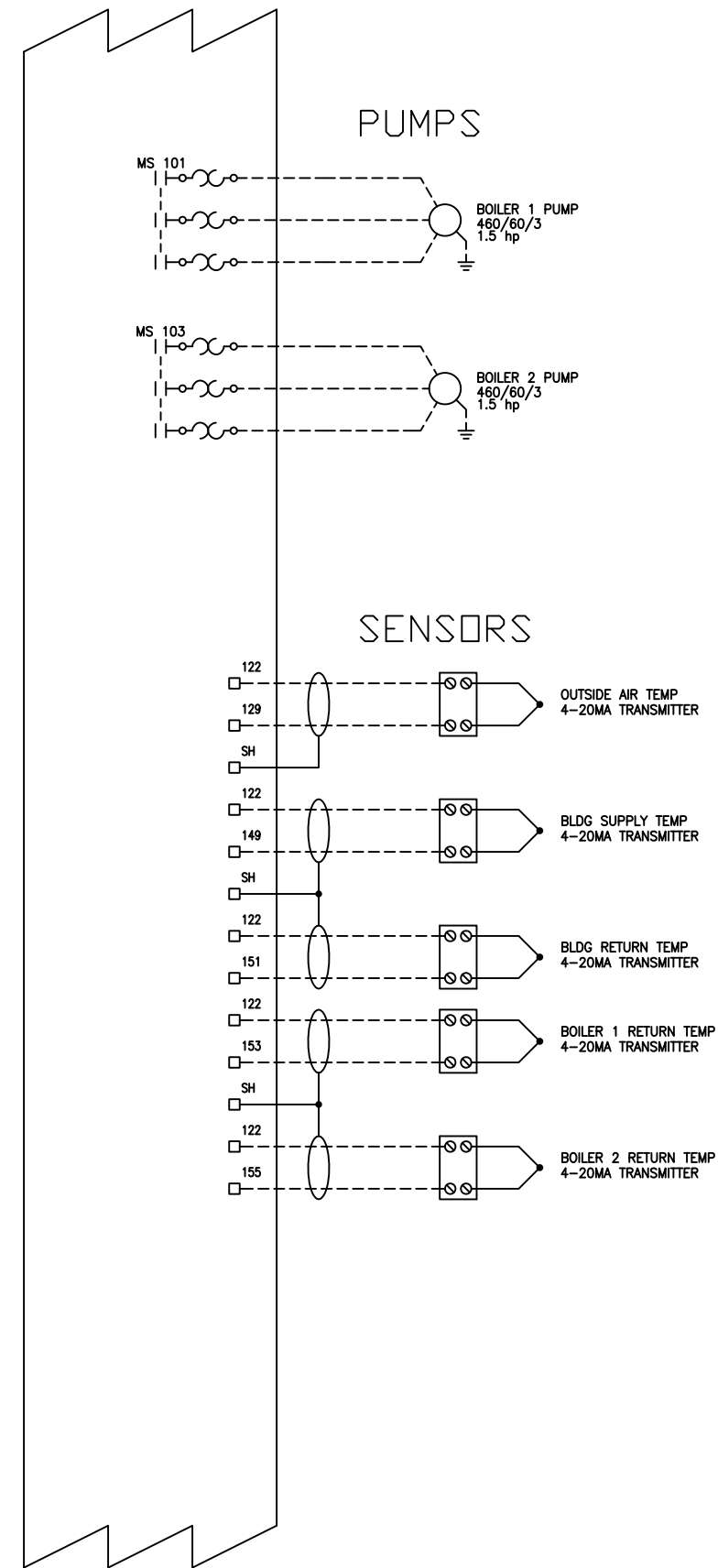

## BOILER CONTROL PANEL

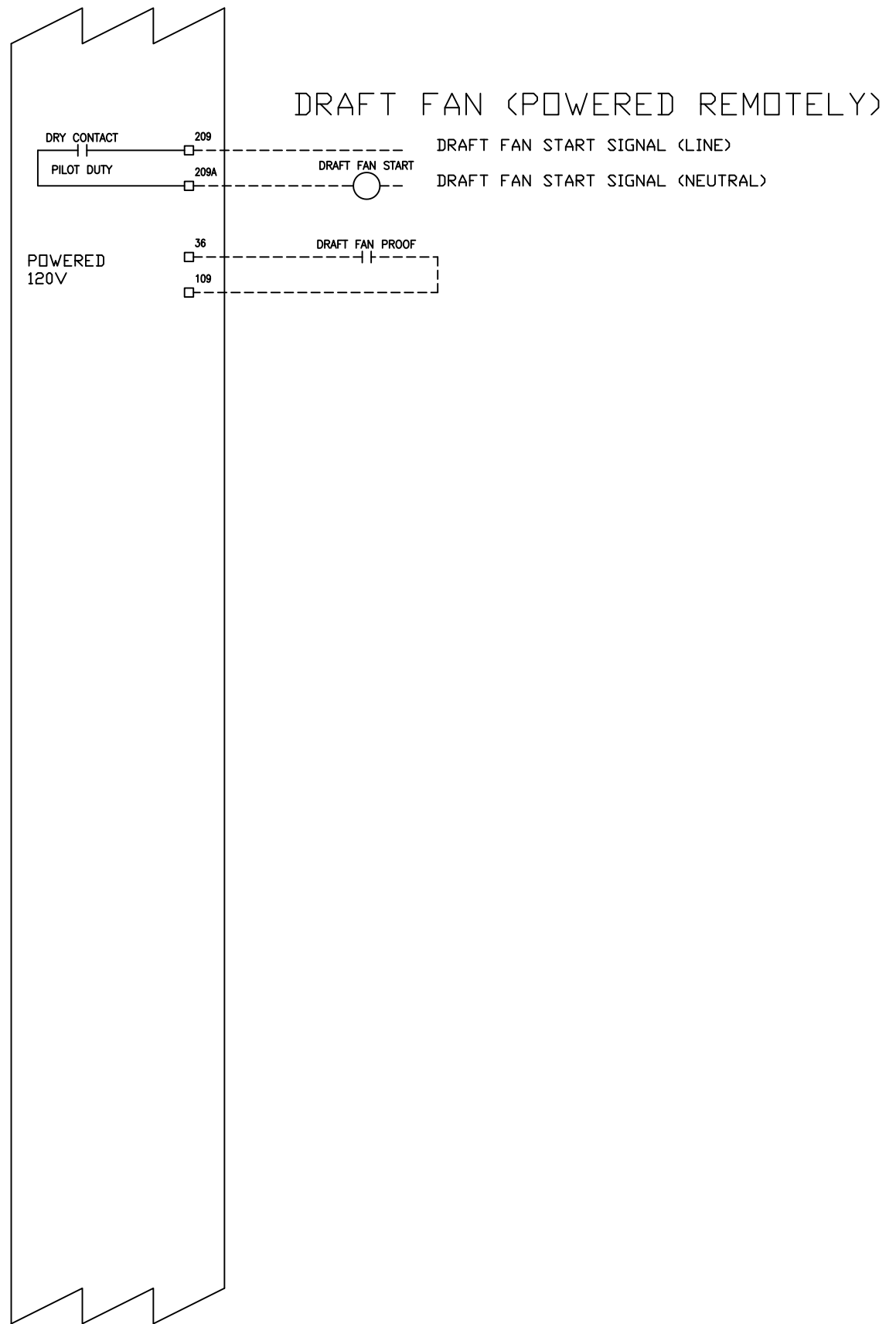

REVISION  
2

THIS DRAWING AND DESIGN IS THE PROPERTY OF PROCTOR SALES, INC. NEITHER THE DRAWING, REPRODUCTION OF IT, NOR INFORMATION DERIVED FROM IT IS TO BE GIVEN TO OTHERS WITHOUT WRITTEN PERMISSION. NO USE IS TO BE MADE WHICH IS OR MAY BE INJURIOUS TO PROCTOR SALES INCORPORATED.

NO.	DATE	BY	REVISION
2	10-20-10	Jmb	SHOW DRY CONTACT, REMOVE MIXING VALVES
2	10-20-10	Jmb	REMOVE BACKUP BLE RET SENSORS

**PROCTOR SALES, INC**  
 27180 SW 95TH AVENUE ST. 3370  
 WILSONVILLE, OREGON 97070  
 503-570-8689

ALASKA - OREGON - WASHINGTON

MCMICKEN HEIGHTS ELEMENTARY  
BOILER CONTROL PANEL

JOB NO	14467-09
DRAWN BY	Jmb
ENGINEER	CHECKED BY
SCALE	DATE
	11-10-09
DWG NO	14467-IC2
SHEET NO	2 OF 13

CAD DWG FILE 14467 MCMicklen Heights Elementary - IC2.dwg

# INTERCONNECT DRAWING (3 OF 3)

REVISION  
2

## BOILER CONTROL PANEL

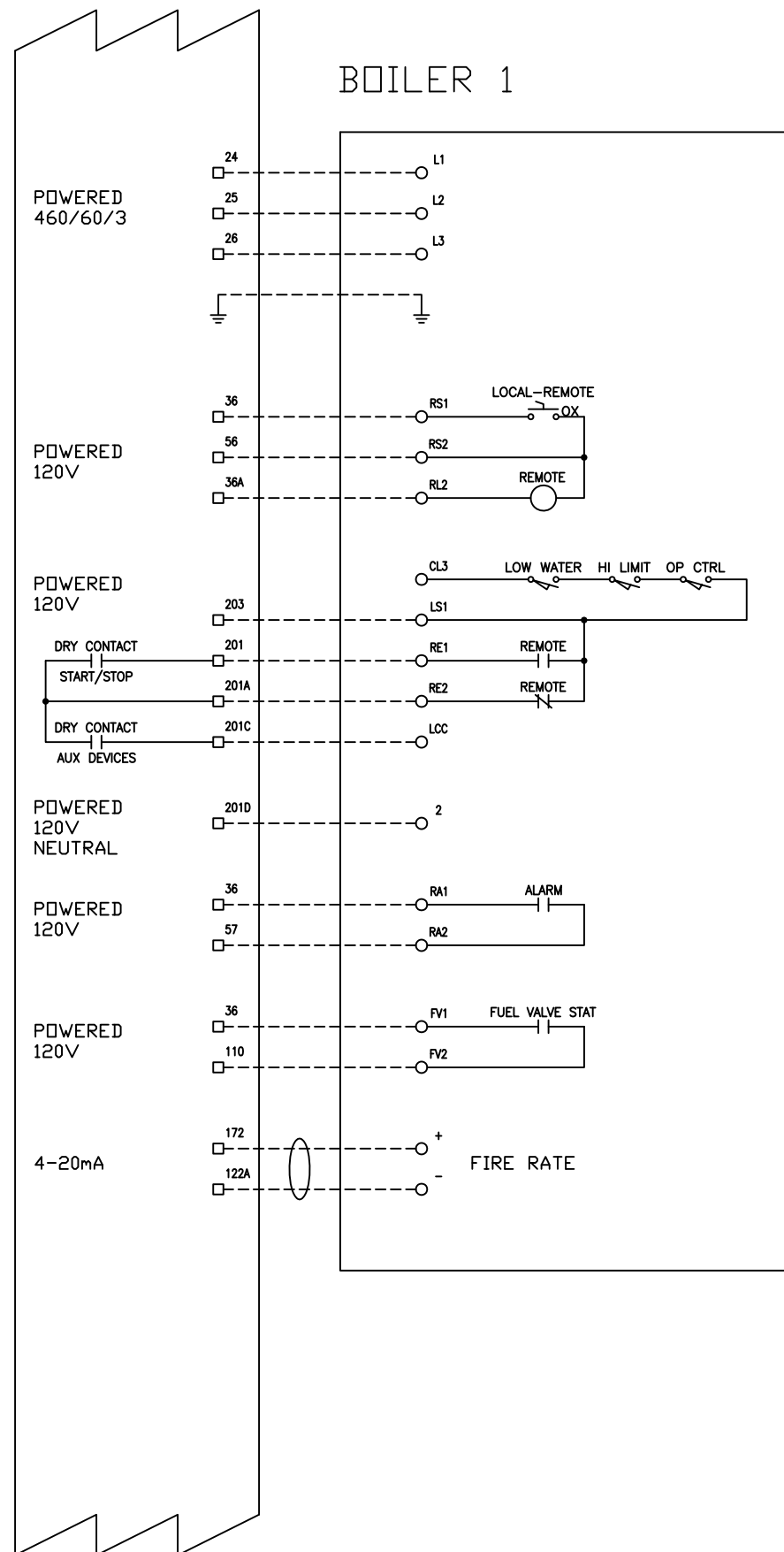

## BOILER CONTROL PANEL

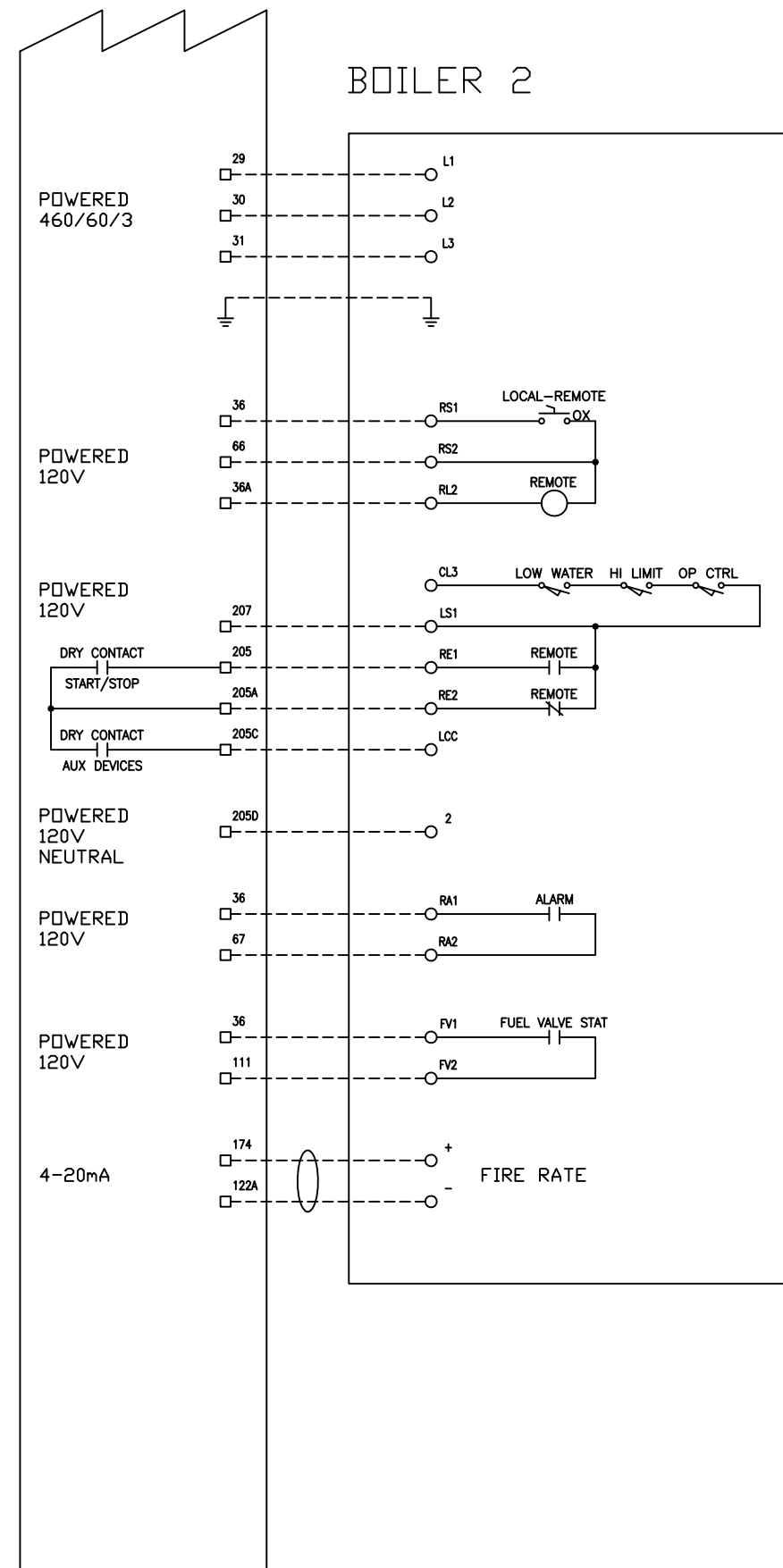

THIS DRAWING AND DESIGN IS THE PROPERTY OF PROCTOR SALES, INC. NEITHER THE DRAWING, REPRODUCTION OF IT, NOR INFORMATION DERIVED FROM IT IS TO BE GIVEN TO OTHERS WITHOUT WRITTEN PERMISSION. NO USE IS TO BE MADE WHICH IS OR MAY BE INJURIOUS TO PROCTOR SALES INCORPORATED.

NO.	DATE	BY	REVISION	CHANGED IF FACE TO MATCH BOILER AS-BUILT WIRING
1	10-18-10	Jmb		

**PROCTOR SALES, INC**  
 27180 SW 95TH AVENUE ST 3370  
 WILSONVILLE, OREGON 97070  
 503-570-8689

PSI

ALASKA - OREGON - WASHINGTON

MCMICKEN HEIGHTS ELEMENTARY BOILER CONTROL PANEL	
JOB NO	14467-09
DRAWN BY	Jmb
ENGINEER	CHECKED BY
SCALE	DATE
	11-10-09
DWG NO	14467-IC3
SHEET NO	3 OF 13

CAD DWG FILE 14467 MCMicken Heights Elementary - IC3.dwg